

B-bitz

Design – Pinc



Introduction

A system that offers unlimited possibilities. Various pouffes in different shapes can be combined with every thing from back rests to light boxes. Over 25 elements for fantastic flexibility.

System med gränslösa möjligheter. Puffar i olika former kan kombineras med allt från ryggstöd till ljusboxar. Över 25 olika delar som ger fantastisk flexibilitet.

Nahezu unendlich kombinierbares System. Verschiedenste Puffs, Rückenlehnen, Leuchtkästen und mehr. Mit 25 Teilen sind Sie unglaublich flexibel.

Système offrant des possibilités infinies. Des poufs de formes diverses peuvent être combinés à des dossiers, des caissons lumineux, etc. Plus de 25 éléments au choix pour une souplesse hors du commun.

JOHANSON

Johanson Design AB | Anders Anderssons Väg 7 | 285 35 Markaryd | Sweden
Tel +46-433 725 00 | www.johansondesign.se

B-bitz

Design – Pinc



Facts - Fakta - Fakten - Faits

Upholstery: For standard material; www.johansondesign.com

Klädsel: För standardmaterial; www.johansondesign.se

Bezug: Für Standard-Material; www.johansondesign.de

Revêtement: Pour matériel standard; www.johansondesign.com

Optional – Tillval – Fakultativ – Optionnel

Buttons / Connector

Knappar / Kopplingsbeslag

Knöpfe / Anschlussarmatur

Boutons / Dispositif de liaison

Certificate – Certificat – Zertifikat – Certifikat



SS-EN 15373:2007 level 2

JOHANSON

Johanson Design AB | Anders Anderssons Väg 7 | 285 35 Markaryd | Sweden
Tel +46-433 725 00 | Fax +46-433 725 05
www.johansondesign.se

B-bitz

Design – Pinc

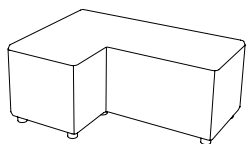

Ben

H: 44

W 1: 72

W 2: 102

D: 42

S: 44

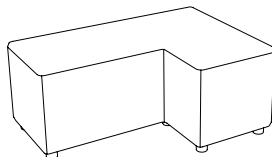

Benny

H: 44

W 1: 72

W 2: 102

D: 42

S: 44

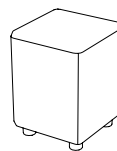

Bib

H: 44

W: 32

D: 32

S: 44

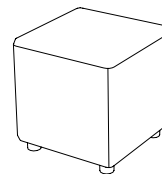

Bill

H: 44

W: 42

D: 42

S: 44

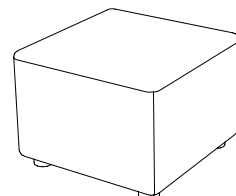

Billy

H: 44

W: 60

D: 60

S: 44

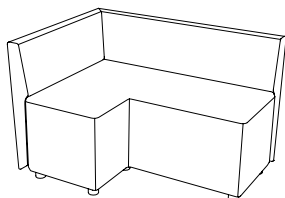

Ben with back

H: 72

W 1: 82

W 2: 112

D: 52

S: 44

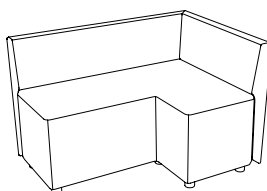

Benny with back

H: 72

W 1: 82

W 2: 112

D: 52

S: 44

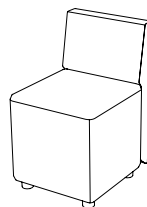

Bill with back

H: 72

W: 42

D: 52

S: 44

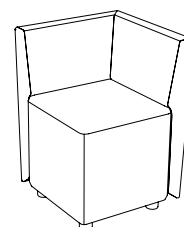

Bill with corner back

H: 72

W: 52

D: 52

S: 44

JOHANSON

Johanson Design AB | Anders Anderssons Väg 7 | 285 35 Markaryd | Sweden
Tel +46-433 725 00 | Fax +46-433 725 05
www.johansondesign.se

B-bitz

Design – Pinc

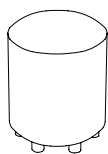

Bob

H: 44

W: 38

D: 38

S: 44

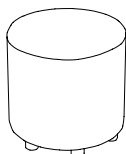

Bongo

H: 44

W: 45

D: 45

S: 44

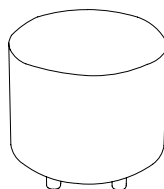

Bobby

H: 44

W: 50

D: 50

S: 44

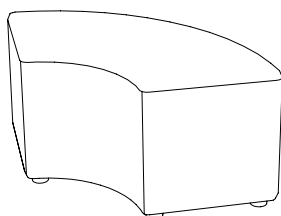

Bond

H: 44

Inner Ø: 60

Ytter Ø: 144

D: 42

S: 44

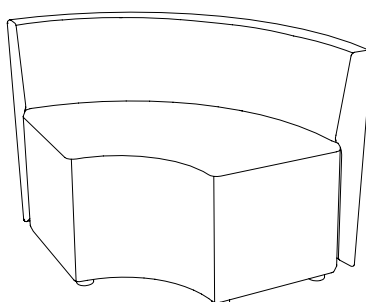

Bond with long back

H: 72

Inner Ø: 60

Ytter Ø: 164

D: 52

S: 44

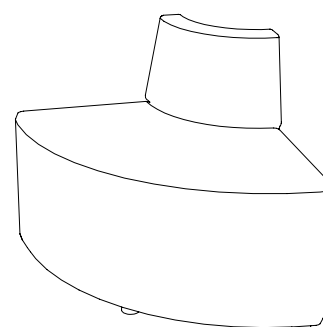

Bond with short back

H: 72

Inner Ø: 40

Ytter Ø: 144

D: 52

S: 44

JOHANSON

Johanson Design AB | Anders Anderssons Väg 7 | 285 35 Markaryd | Sweden
Tel +46-433 725 00 | Fax +46-433 725 05
www.johansondesign.se

B-bitz

Design – Pinc

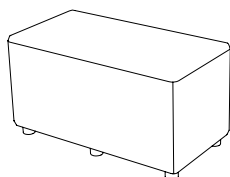

Bull

H: 44

W: 82

D: 42

S: 44

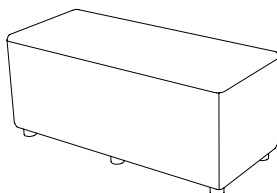

Boxer

H: 44

W: 102

D: 42

S: 44

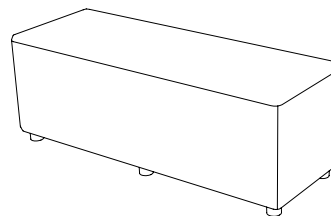

Buster

H: 44

W: 122

D: 42

S: 44

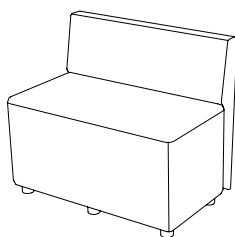

Bull with back

H: 72

W: 82

D: 52

S: 44

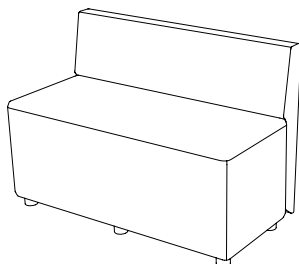

Boxer with back

H: 72

W: 102

D: 52

S: 44

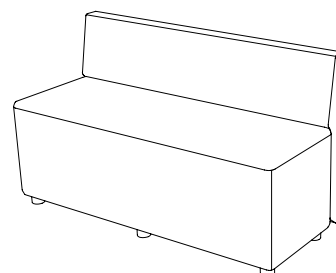

Buster with back

H: 72

W: 122

D: 52

S: 44

JOHANSON

Johanson Design AB | Anders Anderssons Väg 7 | 285 35 Markaryd | Sweden
Tel +46-433 725 00 | Fax +46-433 725 05
www.johansondesign.se

B-bitz

Design – Pinc



BB-Basket

H: 44

W: 15

D: 42



BB-Light

H: 44

W: 15

D: 42



BB-Shelf

H: 44

W: 15

D: 42



BB-Tray

H: 44

W: 33

D: 40



BB-Powerbox

H: 44

W: 15

D: 40



BB-Pie 01



BB-Pie 02



BB-Pie 03



BB-Pie 04



BB-Pie 05 (height +5mm)

JOHANSON
